



Oxford University



## A New Perspective

### Part 1

Sheelagh Treweek, Pete Jones  
Presented by Sheelagh Treweek



Oxford University



## Introduction

- 8 long years service with ADSM/TSM
- Over 3000 clients
  - 2700 desktops
  - 600 servers
- First major capital injection since 1995
- Update of server, storage and network infrastructure



# Oxford University



## What we wanted

- Replace SCSI with FC
- Consolidate storage
- Increase capacity
- Improve performance
- Maintain high availability
- Retain fault tolerance



# Oxford University



## Backup Service History

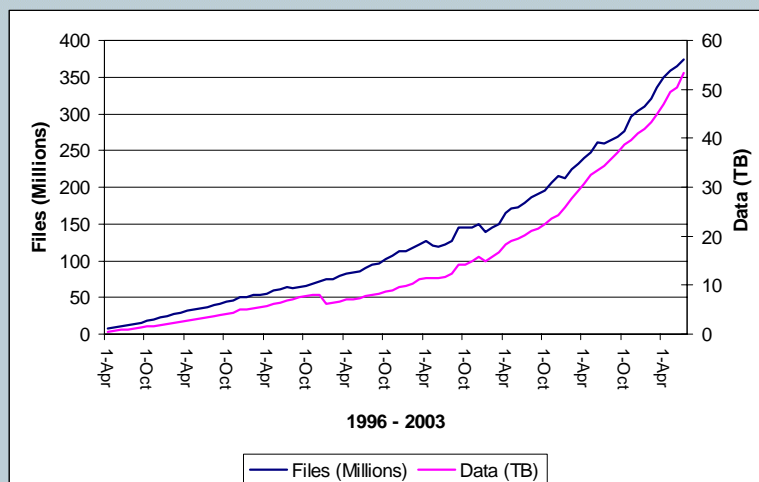

# Oxford University



## Out with the old

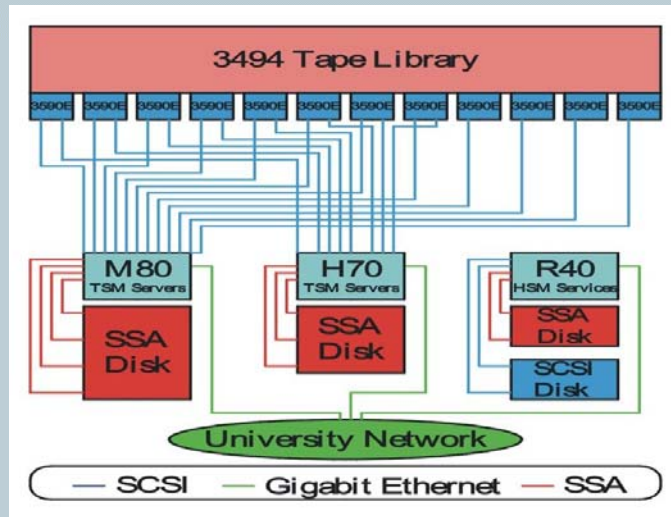

# Oxford University



## In with the new

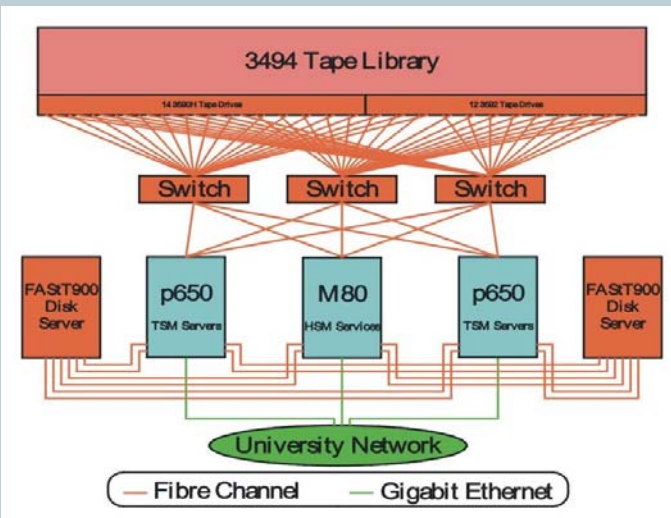



Oxford University



## New experiences

- Our first FC drives (disk and tape)
- Our first SAN switches
- Transition from SCSI to FC
  - Much planning
  - Much testing
  - Relatively painless
- It's been educational ...



Oxford University



## The FASTT900



6 Drawers with 14 36GB  
15K rpm disks each

FASTT RAID Controller  
Dual Active Controllers  
Dual Power Supply  
2GB cache  
2Gbps FC Interface



Oxford University



## We played for weeks!

- Automated testing
  - RAID set configurations
  - Cache settings
  - Segment sizes
  - TSM options
  - Suite of perl scripts running every day
- Found optimum setup for us
- More details in the paper



Oxford University



## Our DB Bufferpool puzzle!

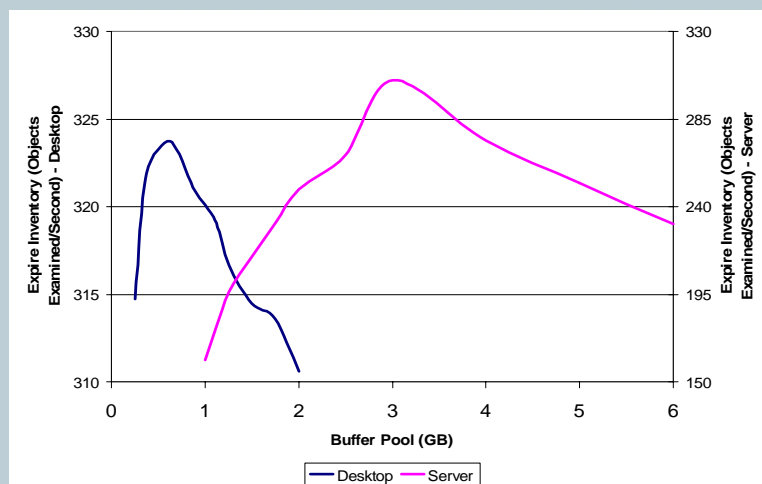



### Summary - 2003

Q1	Q2	Q3	Q4
<ul style="list-style-type: none"><li>• Design</li><li>• FAStT</li><li>• P650</li><li>• Delivery</li></ul>	<ul style="list-style-type: none"><li>• Install</li><li>• Test</li><li>• Service</li></ul>	<ul style="list-style-type: none"><li>• 3592s</li><li>• Delivery</li><li>• Test</li></ul>	<ul style="list-style-type: none"><li>• Service</li><li>• Evaluate</li></ul>



### Benefits (Q2)

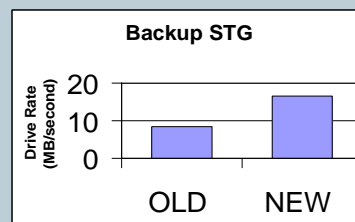
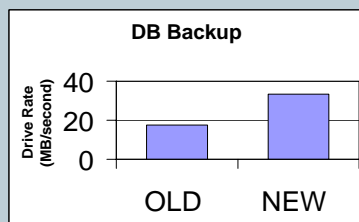
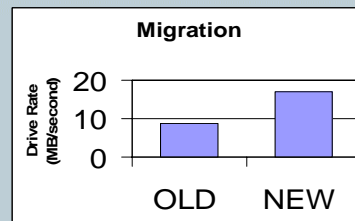



Oxford University



## What's next?

Q4

- Finish deployment
- Exploit the new technology

This Afternoon...  
A New Perspective: Part 2  
Focus on Tape Technology  
With Pete Jones



Oxford University



Thank You